

GYNECOLOGY

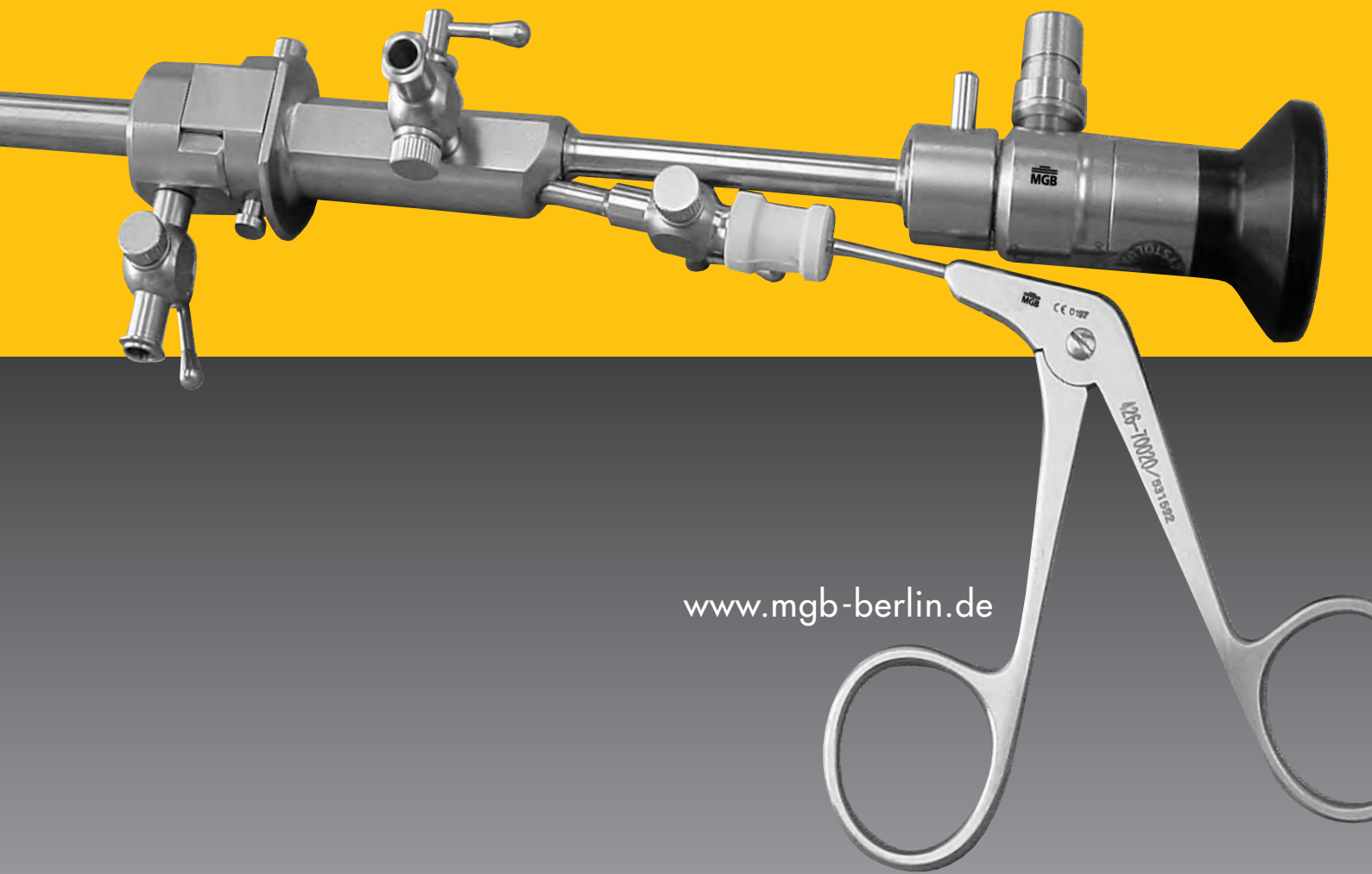

www.mgb-berlin.de

MGB

CONTENT

System for Ø 2.9 mm- Telescopes (Round Style)

Page 3-4

System for Ø 4.0 mm- Telescopes (Round Style)

Page 5-6

System for Ø 2.9/Ø 4.0 mm- Telescopes (Drop Style)

Page 7

Instruments

Page 8

Uterusmanipulator

Page 9

Irrigation - Pump

Page 10-11

Cohen - Probes

Page 12

HYSTEROSCOPY

SYSTEM FOR Ø 2.9 mm - TELESCOPES

Products

Order-No.

Description

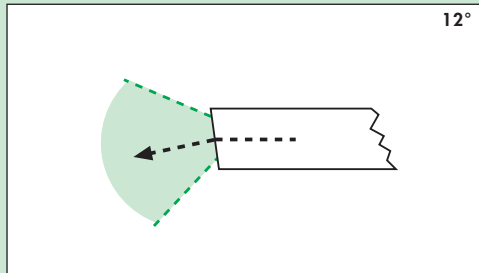

426-30000

Hystolux-Telescope 12°

- Direction of view 12°
- Outer-diameter: Ø 2.9 mm
- Working length: 300 mm
- Connector for Storz/Wolf/ACMI light guide

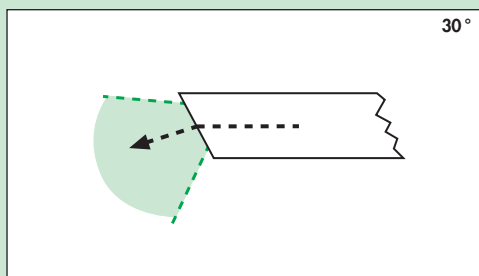

426-29000

Hystolux-Telescope 30°

- Direction of view 30°
- Outer-diameter: Ø 2.9 mm
- Working length: 300 mm
- Connector for Storz/Wolf/ACMI light guide

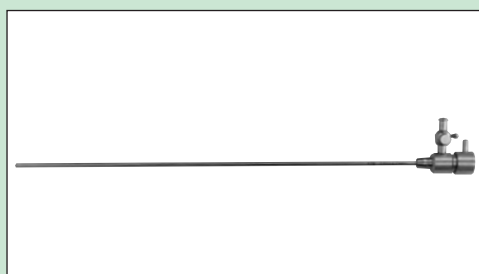

426-32920

Examination-Shaft

- For Ø 2.9 mm /30°- telescope
- Outer-diameter: Ø 3.7 mm
- Working length: 270 mm
- 1 Luer-Lock stopcock

Round Style

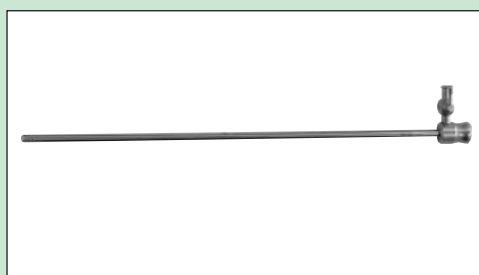

426-32922

Continuous Flow-Shaft for Examination-Shaft

- For Order-No.: 426-32920
- Outer-diameter: Ø 5 mm
- Working length: 260 mm
- Easy snap

Round Style

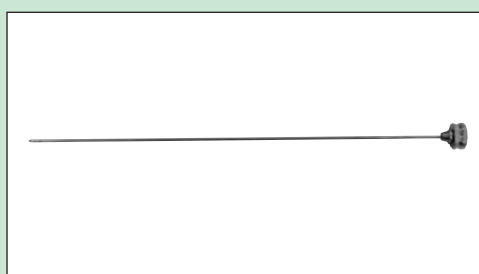

426-32910

Obturator for Examination-Shaft

- For Order-No.: 426-32920
- Tip like Hegar

HYSTEROSCOPY

SYSTEM FOR Ø 2.9 mm - TELESCOPES

Products

Order-No.

Description



Continuous Flow-Operating Hysteroscope

Round Style

System consisting of:

426-32960
426-32950
426-32940
426-29000

- Inner-shaft
- Outer-shaft
- Obturator
- Hystolux-Telescope 30°
(see page 3)



426-32960

Inner-Shaft for Ø 2.9 mm Operating-Hysteroscope

- For Ø 2.9 mm/30°-telescope
- Working channel: Ø 5 Fr. lockable
- 1 Luer-Lock stopcock
- With continuous flow

412-90001

Sealing Caps for working channel

- 10 pcs.

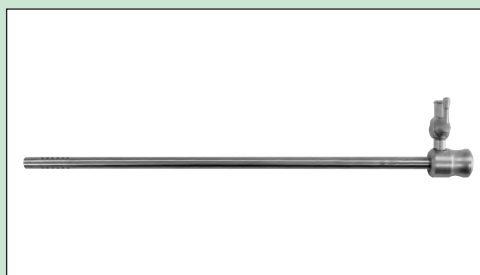

426-32950

Outer-Shaft for Ø 2.9 mm Operating-Hysteroscope

Round Style

- Outer-diameter: Ø 5.9 mm
- Working length: 190 mm
- 1 Luer-Lock stopcock
- Easy snap
- With continuous flow

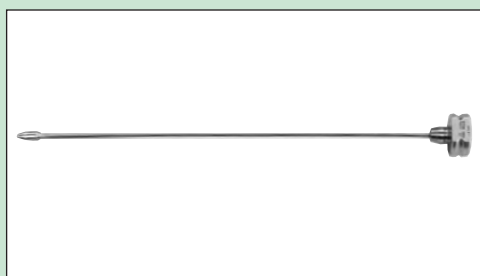

426-32940

Obturator for Ø 2.9 mm Operating-Hysteroscope

- For outer-shaft
- For Order-No.: 426-32950
- Tip like Hegar

HYSTEROSCOPY

SYSTEM FOR Ø 4.0 mm-TELESCOPES

Products

Order-No.

Description

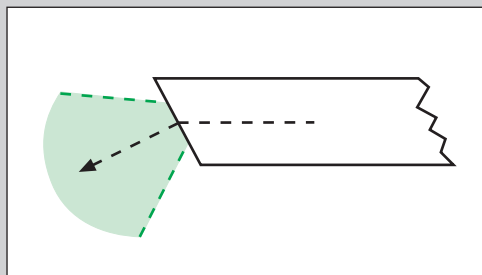

426-19500

Hystolux-Telescope 30°

- Direction of view 30°
- Outer-diameter: Ø 4 mm
- Working length: 300 mm
- Connector for Storz/Wolf/ACMI light guide

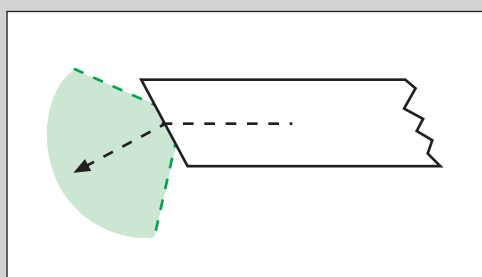

426-19600

Hystolux-Telescope 30°

Wide-angle

- Direction of view 30°
- Outer-diameter: Ø 4 mm
- Working length: 300 mm
- Connector for Storz/Wolf/ACMI light guide

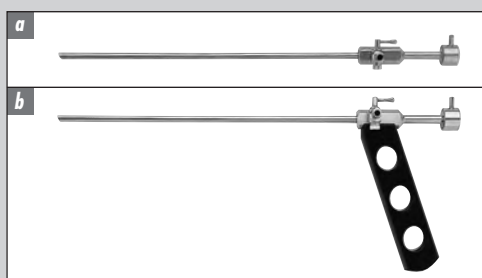

a 426-34020

a Examination-Shaft without Handle

Round Style

- For Ø 4 mm/30°-telescope
- Outer-diameter: Ø 5 mm
- Working length: 230 mm
- 1 Luer-Lock stopcock

b 426-34021

b Examination-Shaft with Handle

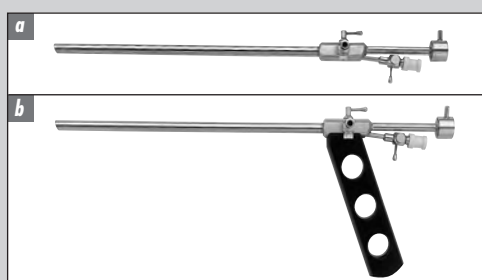

a 426-34030

a Working-Shaft without Handle

Round Style

- For Ø 4 mm/30°-telescope
- Outer-diameter: Ø 7.5 mm
- Working length: 205 mm
- Working channel: Ø 7 Fr. lockable
- 2 separate channels
- 1 Luer-Lock stopcock

b 426-34031

b Working-Shaft with Handle

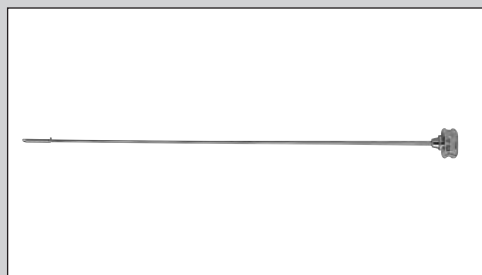

426-34010

Obturator

- For Order-No.:
426-34020/426-34021
426-34030/426-34031

HYSTEROSCOPY

SYSTEM FOR Ø 4.0 mm - TELESCOPES

Products

Order-No.

Description

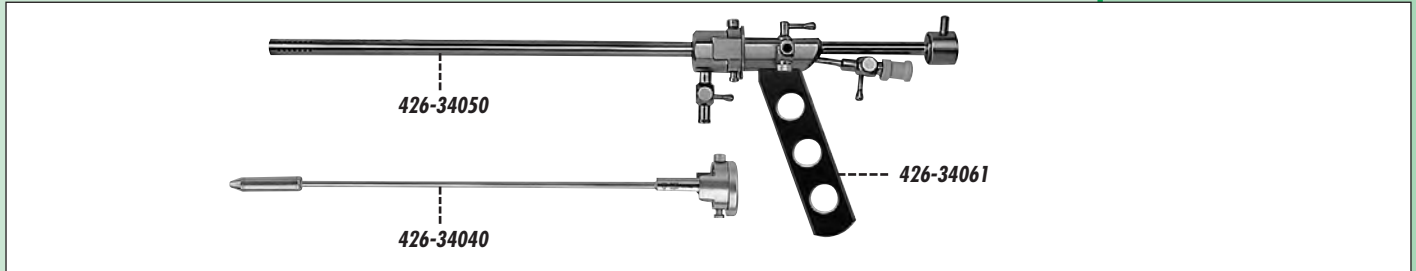

Continuous Flow-Operating Hysteroscope

- With snap-in connection-system

System consisting of:

- Outer-shaft
- Obturator
- Inner-shaft **or**
- Inner-shaft with handle
- For Hystolux-telescope 30° **or**
- For Hystolux-telescope wide-angle 30°

426-34050
426-34040
426-34060
426-34061
426-19500
426-19400

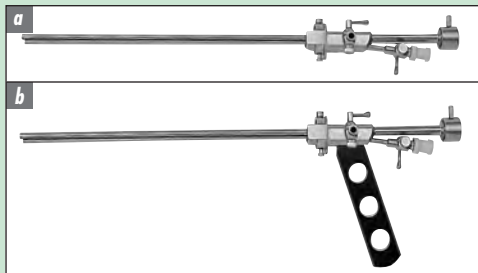

a 426-34060

a Inner-Shaft for Operating-Hysteroscope without Handle

- For Ø 4 mm/30°-telescope
- Working channel: Ø 7 Fr. lockable
- 1 Luer-Lock stopcock

b 426-34061

b Inner-Shaft for Operating-Hysteroscope with Handle

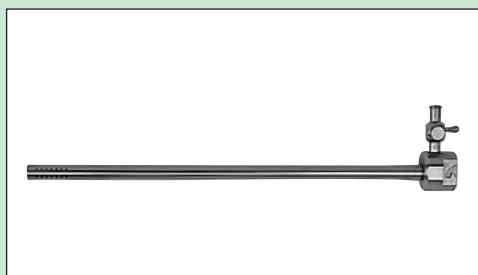

426-34050

Outer-Shaft for Operating-Hysteroscope

- With continuous flow
- Outer-diameter: Ø 8 mm
- Working length: 180 mm
- 1 Luer-Lock stopcock

Round Style

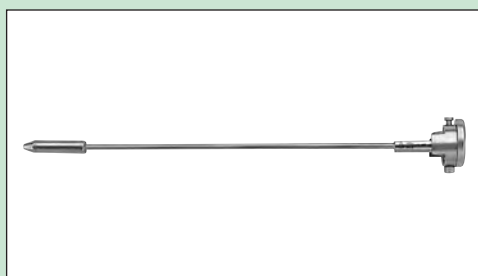

426-34040

Obturator for Operating-Hysteroscope

- For outer-shaft (426-34050)

HYSTEROSCOPY

SYSTEM FOR Ø 2.9/Ø 4.0 mm-TELESCOPES

Products

Order-No.

Description

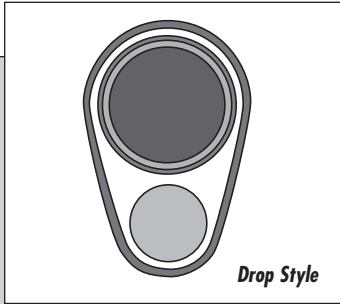

**Continuous Flow-Operating
Hysteroscope**

System consisting of:

- Inner-shaft
- Outer-shaft
- For Ø2.9 mm/Ø 4.0 mm telescope

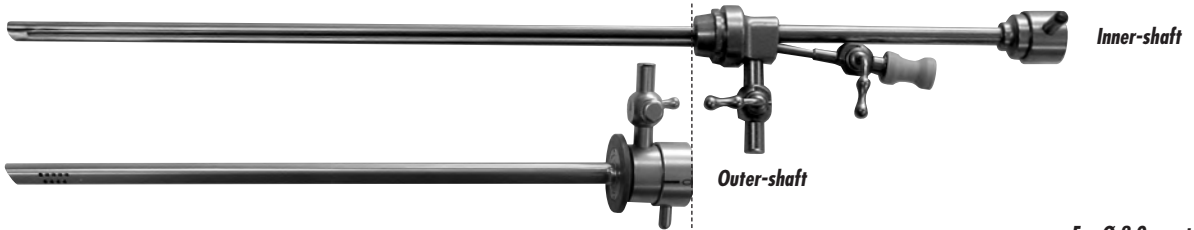

For Ø 2.9 mm telescope

426-32810

Continuous Flow with 2 Stopcocks

- Drop style
- Working channel: Ø 5 Fr.
- Working length: 190 mm
- In-/outflow
- For telescope

Order-No. 426-29000

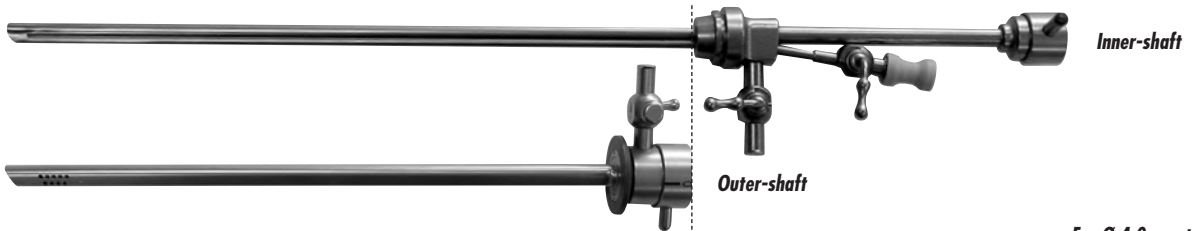

For Ø 4.0 mm telescope

426-32820

Continuous Flow with 2 Stopcocks

- Drop style
- Working channel: Ø 5 Fr.
- Working length: 190 mm
- For telescope

Order-No. 426-19500

HYSTEROSCOPY

INSTRUMENTS

Products

Order-No.

Description

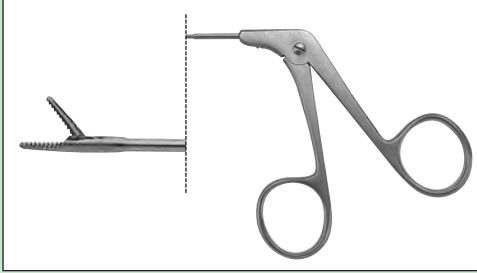

426-70010 (6 Fr.)
(picture)

Semi Rigid Grasping Forceps

- Single-movable
- Working length: 320 mm

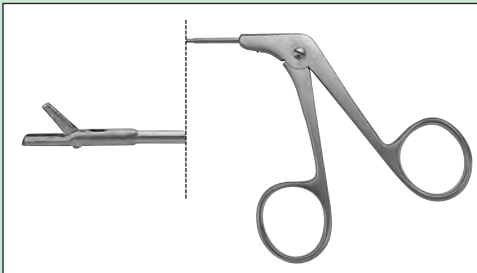

426-70015 (5 Fr.)

Semi Rigid Grasping Forceps

- Double-movable
- Working length: 320 mm

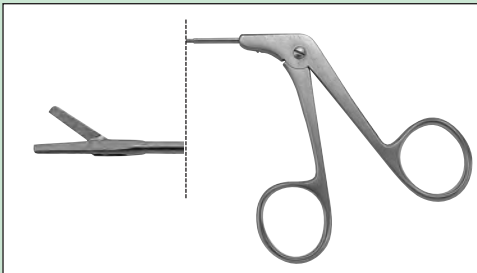

426-70020 (6 Fr.)
(picture)

Semi Rigid Biopsy Punch

- Single-movable
- Working length: 320 mm

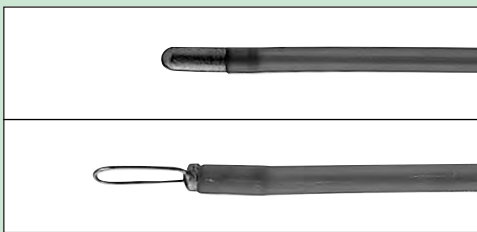

426-70025 (5 Fr.)

Semi Rigid Biopsy Spoon

- Double-movable
- Working length: 320 mm

426-70030 (6 Fr.)
(picture)

Semi Rigid Scissors Straight

- Single-movable
- Working length: 320 mm

426-70035 (5 Fr.)

Semi Rigid Scissors Straight

- Single-movable
- Working length: 320 mm

426-80010 (5 Fr.)
426-80014 (4 Fr.)

HF-Button Electrode

- Working length: 530 mm

426-80020 (5 Fr.)

HF-Loop Electrode

- Working length: 530 mm



426-80030 (5 Fr.)
426-80034 (4 Fr.)

HF-Needle Electrode

- Working length: 530 mm



426-80050

Uterus Grasping Forceps

UTERUSMANIPULATOR

Products

Order-No.

Description



426-50110

Uterusmanipulator

■ Without adapter

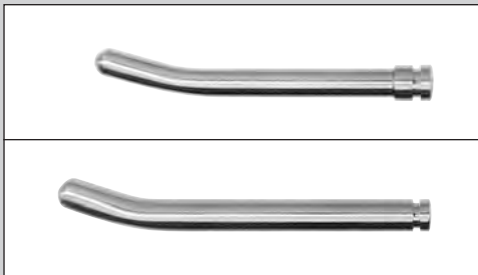

426-50116

Adapter

■ Ø 80 x 80 mm

426-50115

■ Ø 10 x 100 mm

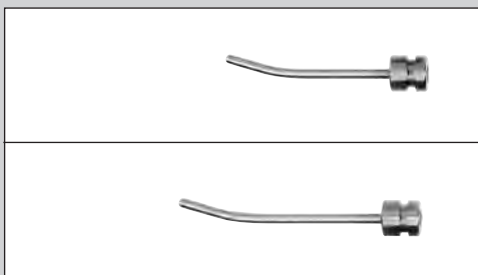

426-50114

Adapter

■ Ø 3 x 45 mm

426-50113

Adapter

■ Ø 3 x 55 mm

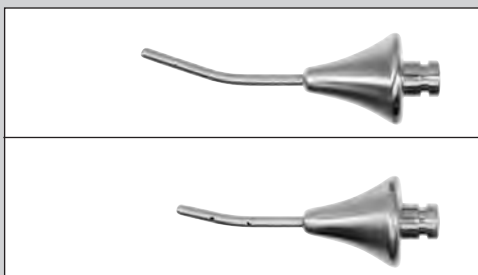

426-50112

Adapter with Conus/long

426-50111

Adapter with Conus/short

HYSTEROSCOPY- PUMP

Order-No. 670-96800



Intended Use

The device is an *Irrigation-Pump* with an optimal balancing system for hysteroscopic application. It is used to introduce fluids into the vacuum uteri.

Indications

The device is indicated for liquid distension of the uterus for diagnostic and operative hysteroscopic and monitoring the volume differential between the irrigation fluid flowing into and out of the uterus.

Technical Application Scope of the Device

The nominal value for the intrauterine pressure and the desired flow rate can be set at the device. The nominal pressure can be preset to ranges between 15 to 100 mg Hg and 100 to 150 mg Hg. The nominal flow has three increments and can be preset to between 30-500 ml/min.

All devices to be connected to the *Hysteroscopic-Pump* have to correspond to the IEC-601 standards and to other actual IEC/ISO standards valid for particular devices.

GENERAL

<i>Order-No.</i>	
670-96800	Irrigation-Pump
<i>Main Connection</i>	
Power supply	~100 - 250 V
Frequency	50 - 60 Hz
Power consumption	45 VA
<i>Classification</i>	
Safety class	1 with potential equalization connection
Protection	IP 41
Type	BF
Approval	CE, II b
Pressure range	15-150 mm Hg
Flow rate	30-500 ml/min.
High pressure safety	200 mm Hg
<i>Extent of Delivery</i>	
Irrigation-Pump	<ul style="list-style-type: none"> ■ User manual ■ Main power cable

SPECIFICATION

<i>Connection</i>	
Container scale and bottle scale	
<i>Dimension and Weight</i>	
Dimension (w/h/d)	360 x 268 x 137 mm
Weight	4 kg

<i>Order-No.</i>	<i>Accessories</i>
670-96410 (1 pc.)	Limited use tubing set, Silicone (inflow)
670-96420 (10 pcs.)	Disposable tubing set, PVC (inflow)
670-96505 (10 pcs.)	Disposable tubing set, PVC (outflow) to scales
670-96520	Bottle scale
670-96460 (10 pcs.)	Membrane for pressure chambre for limited use for tubing set

HYSTEROSCOPY

COHEN-PROBES

Products

Order-No.

Description



426-50103

Cohen Probe

■ Complete incl. adapter

426-50100

Consisting of:

■ Cohen-probe without adapter

426-50101

Portio Adapter /small

■ Ø: 18 mm

■ L: 28 mm

426-50102

■ **Portio Adapter /large**

■ Ø: 24 mm

■ L: 30.5 mm

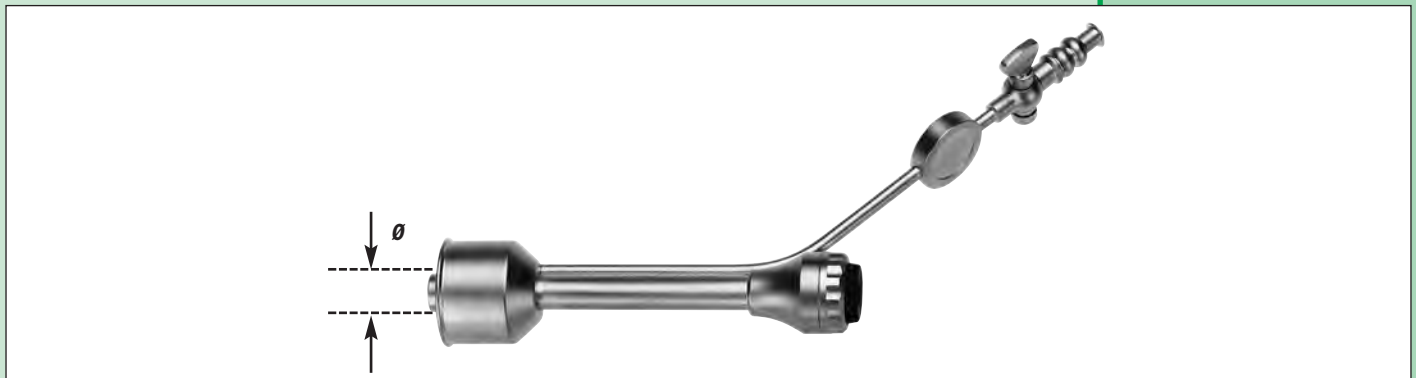

426-50105

Hysteroscopy Adapter /small

■ Ø: 10.5 mm

426-50106

Hysteroscopy Adapter /large

■ Ø: 16 mm

MGB Endoskopische Geräte GmbH Berlin

Schwarzschildstrasse 6 · 12489 Berlin, Germany

Phone: +49-30-63 92 -70 10

Fax: +49-30-63 92 -70 11

E-mail: sales@mgb-berlin.de

Internet: www.mgb-berlin.de